

## ENGINES

Type
Configuration
Displacement, cm <sup>3</sup>
Bore (mm)
Stroke (mm)
Engine cylinder block material
Cylinder head material
Compression ratio
Valves, no/cylinder
Camshafts
Engine management system
Ignition sequence
Engine idling speed, rpm
Fuel, rec. octane
Max output, kW (hp)/rpm
Max torque, Nm/rpm

<b>T5</b> (B4204T23)
In-line 4-cyl. turbocharged
Transverse, front wheel drive
1969
82.0
93.2
Aluminium
Aluminium
10.8:1
4
2
Gasoline direct injection
1 - 3 - 4 - 2
850±100
95-98 RON
187 (254)/5500
350/1500-4800

<b>T6 AWD</b> (B4204T27)
In-line 4-cyl. supercharged and turbocharged
Transverse, all wheel drive
1969
82.0
93.2
Aluminium
Aluminium
10.3:1
4
2
Gasoline direct injection
1 - 3 - 4 - 2
850±100
95-98 RON
235 (320)/5700
400/2200-5400

<b>T8 AWD</b> (B4204T35)
In-line 4-cyl. supercharged and turbocharged
Transverse, front wheel drive, rear electric motor
1969
82.0
93.2
Aluminium
Aluminium
10.3:1
4
2
Gasoline direct injection
1 - 3 - 4 - 2
850±100
95-98 RON
235 (320)/5700
400/2200-5400

## POWER AND TORQUE →

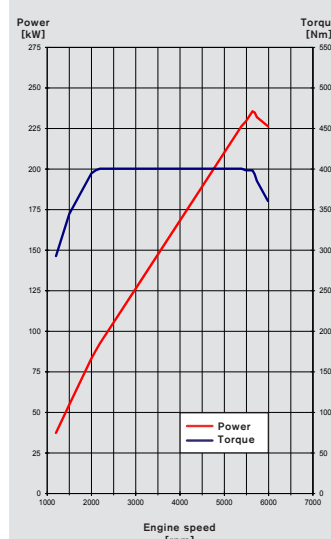
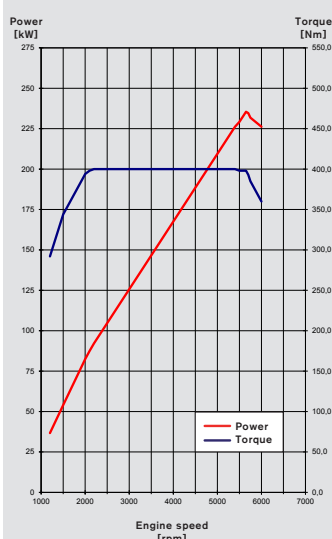
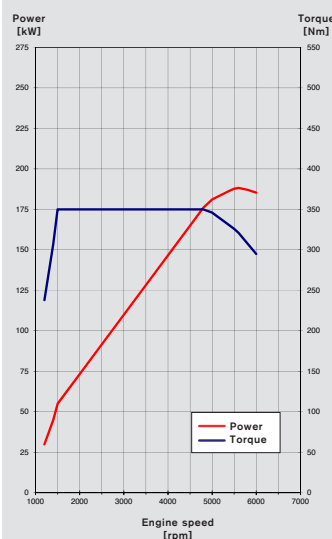

Manual gearbox/final drive
Automatic gearbox/final drive
<b>PERFORMANCE</b>
Gearbox
Acceleration, 0-100 km/h (sec)
Top speed, km/h
Fuel consumption l/100 km (combined)
CO <sub>2</sub> g/km

-	
AW TG-81SC	3.075
Automatic	
7.0	
230	
6.8	
154	

-	
AW TG-81SC	3.200
Automatic	
6.1	
250	
7.4	
169	

-	
AW TG-81SD	3.200
Automatic	
4.8	
250	
2.1	
47	

Battery type
Battery content, total amount of energy (kwh)
Battery charging time*, at 16A/10A/6A fuse (hours)
Range (Km) (NEDC for hybrids)
Electrical motor max power (kW/rps)
Electrical motor max torque (Nm/rps)
Driveline max power (hp)
Driveline max power (kW)
Driveline max torque (Nm)
Battery placement

Lithium-ion battery
9.2
2.5/3.5/6.0
>45 km**
65/117
240/0-50
~407 (320 + 87)
~300 (235*** + 65)
~640 (400*** + 240)
Centrally in the tunnel of the car

\*) Time pending on e.g. ambient temp  
 \*\*) Pure electrical range according to NEDC cycle range  
 \*\*\*) In "Hybrid"-, Power\*- and "EL-AWD"-mode

**ENGINES**

Type
Configuration
Displacement, cm <sup>3</sup>
Bore (mm)
Stroke (mm)
Engine cylinder block material
Cylinderhead material
Compression ratio
Valves, no/cylinder
Camshafts
Engine management system
Ignition sequence
Engine idling speed, rpm
Fuel
Max output, kW (hp)/rpm
Max torque, Nm/rpm

<b>D3 (D4204T9)</b>
In-line 4-cyl. turbo diesel
Transverse, front wheel drive
1969
82.0
93.2
Aluminium
Aluminium
16.0:1
4
2
i-Art common rail direct injection
1 - 3 - 4 - 2
825 ± 150
Diesel*
110 (150)/3750
320/1750–3000

<b>D3 AWD (D4204T4)</b>
In-line 4-cyl. twin turbo diesel
Transverse, all wheel drive
1969
82.0
93.2
Aluminium
Aluminium
15.8:1
4
2
i-Art common rail direct injection
1 - 3 - 4 - 2
825 ± 150
Diesel*
110 (150)/4250
350/1500–2500

**POWER AND TORQUE →**

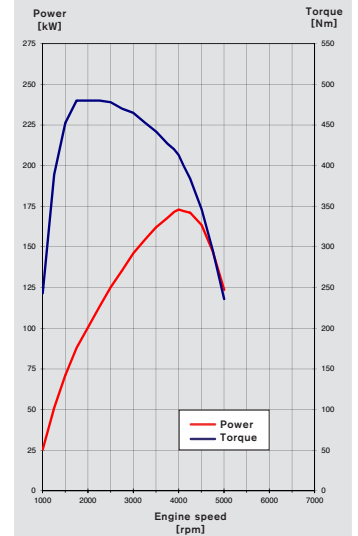
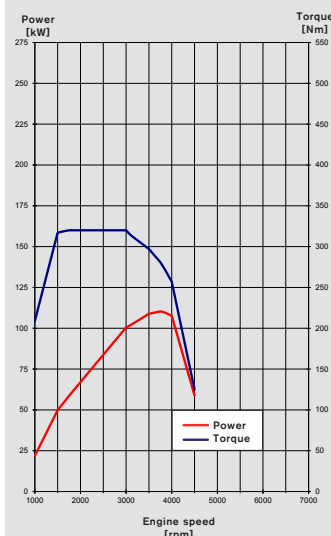

Manual gearbox/final drive
Automatic gearbox/final drive
<b>PERFORMANCE</b>
Gearbox
Acceleration, 0–100 km/h (sec)
Top speed, km/h
Fuel consumption l/100 km (combined)
CO <sub>2</sub> g/km

M66F	4.000
AW TF-71SC	3.502
Man	Automatic
10.2	10.2
205	205
4.5 (4.5**)	4.5 (4.4**)
119 (116**)	119 (116**)

-	
AW TG-81SC	3.075
	Automatic
	10.5
	205
	4.9
	128

\*According to EN590  
Maximum biodiesel (FAME) content 7%  
\*\*Restricted offer

\*According to EN590  
Maximum biodiesel (FAME) content 7%

**TRANSMISSIONS**

- 6-speed manual gearbox
- 6-speed automatic gearbox
- 8-speed automatic gearbox

RATIO	M66F	AW TF-71SC	AW TG-81SC	AW TG-81SD
First	3.583	4.044	5.250	5.250
Second	2.050	2.371	3.029	3.029
Third	1.267	1.556	1.950	1.950
Fourth	0.838	1.159	1.457	1.457
Fifth	0.617	0.852	1.221	1.221
Sixth	0.510	0.672	1.000	1.000
Seventh	-	-	0.809	0.809
Eighth	-	-	0.673	0.673
Reverse	2.833	3.193	4.015	4.015

**ENGINES**

Type
Configuration
Displacement, cm <sup>3</sup>
Bore (mm)
Stroke (mm)
Engine cylinder block material
Cylinderhead material
Compression ratio
Valves, no/cylinder
Camshafts
Engine management system
Ignition sequence
Engine idling speed, rpm
Fuel
Max output, kW (hp)/rpm
Max torque, Nm/rpm

**POWER AND TORQUE →**

Manual gearbox/final drive
Automatic gearbox/final drive
<b>PERFORMANCE</b>
Gearbox
Acceleration, 0–100 km/h (sec)
Top speed, km/h
Fuel consumption l/100 km (combined)
CO <sub>2</sub> g/km

<b>D4/D4 AWD (D4204T14)</b>
In-line 4-cyl. twin turbo diesel
Transverse, front & all wheel drive
1969
82.0
93.2
Aluminium
Aluminium
15.8:1
4
2
i-Art common rail direct injection
1 - 3 - 4 - 2
825 ± 150
Diesel*
140 (190)/4250
400/1750–2500

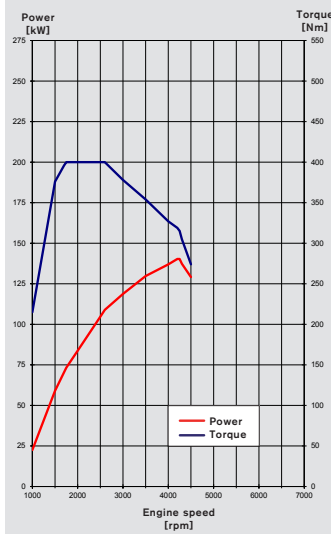

M66F	4.000
AW TG-81SC	2.955
Man	Automatic FWD/AWD
8.5	8.5/8.7
225	225/225
4.5	4.5/4.9
119	119/128

\*According to EN590  
Maximum biodiesel (FAME) content 7%

<b>D5 AWD (D4204T23)</b>
In-line 4-cyl. twin turbo diesel
Transverse, all wheel drive
1969
82.0
93.2
Aluminium
Aluminium
15.8:1
4
2
i-Art common rail direct injection
1 - 3 - 4 - 2
825 ± 150
Diesel*
173 (235)/4000
480/1750–2250

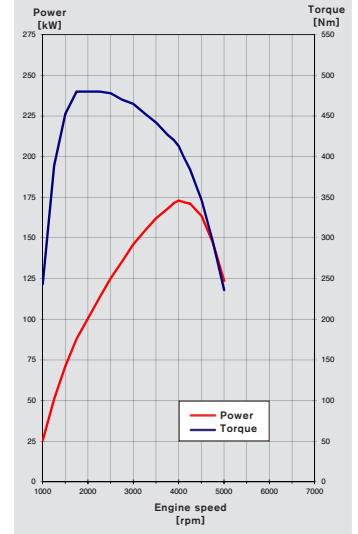

-	
AW TG-81SC	3.075
	Automatic
	7.2
	240
	4.9
	129

\*According to EN590  
Maximum biodiesel (FAME) content 7%

**MEASUREMENTS AND VOLUMES**

**EXTERIOR MEASUREMENTS (CM)**

Length	493.6
Body width	187.9
Width (door mouldings)	189.0
Width (Incl mirrors, outhter edge)	201.9
Height (including shark fin antenna)	147.5
Wheelbase	294.1
Overhang (front/rear)	87.3/112.2
Track, front, (17"+18"/19"/20"/21")	162.8/161.8/161.7/162.3
Track, rear, (17"+18"/19"/20"/21")	162.9/161.9/161.8/162.4
Ground clearance, curb	15.3

**WEIGHTS/MISCELLANEOUS**

Weight, kg (min-max, depending on setup)	1832-2100
Fuel tank, l (FWD/AWD/B4204T35)	55/60/50
Max. trailer weight, kg	1800-2200*
Max roof load, kg	100
Drag coefficient, Cd	0.30-0.33

\* TOWKIT required, otherwise 1800 kg

**INTERIOR MEASUREMENTS (CM)**

Headroom without panoramic sunroof (front/rear) (H61-1/H61-2)	98.3/96.6
Headroom without panoramic sunroof (front/rear) (H61-1-SR/H61-2-SR)	95.9/95.7
Headroom maximum, without panoramic sunroof (front) (H62-1)	102.6
Headroom maximum, without panoramic sunroof (front) (H62-1-SR)	100.6
Passenger compartment width at shoulder height (front/rear) (W3-1/W3-2)	146.0/142.0
Leg room (front/rear) (L34/L51-2)	107.1/91.1
Luggage volume, including under floor storage, litres (V211-1/ V214-1)	913/1526
Cargo length from the first seatback to the tailgate (SAE L202-1)	198.8
Cargo length from the second seatback to the tailgate (SAE L202-2)	115.3
Cargo floor height to ground (H253)	61.0
Width of luggage compartment between wheelhouses (W202)	110.0

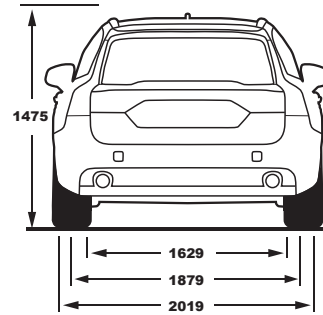
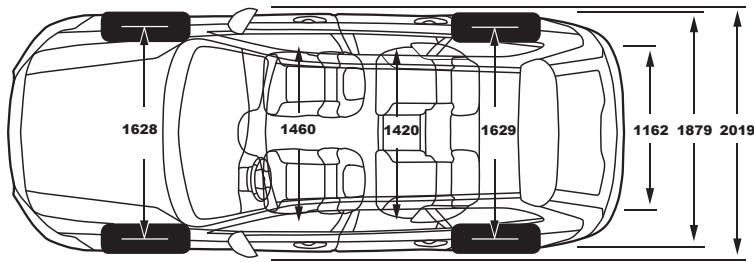
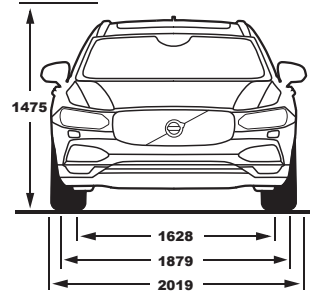
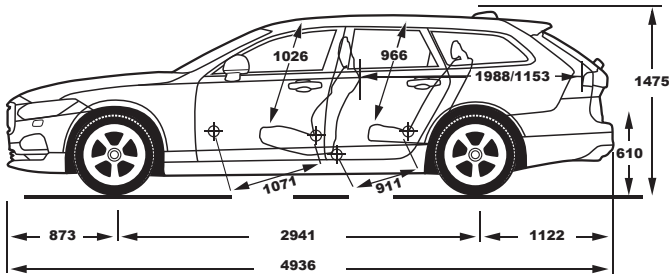

**CHASSIS**

Suspension	front	Double Wishbone Suspension, Coil Springs, Hydraulic Shock Absorbers, Stabilizer Bar.
	rear	Integral Axle with Transverse Composite Leaf Spring, Hydraulic Shock Absorbers, Stabilizer Bar, Optional Air Suspension
Steering		Electric Power Assisted Rack and Pinion Steering
Turning circle, curb to curb		11.4 m-11.8 m (depending on wheel size)
Braking system		Antilock Braking System (ABS) with Electronic Brake Distribution (EBD) and Electronic Brake Assistance (EBA)
Braking distance, 100-0 km/h		35 m
Brake disc diameter	front	296 mm/322 mm/345 mm (brake disc; 16",17",18")
	rear	302 mm/320 mm (brake disc; 16",17")